

















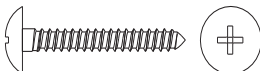
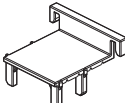



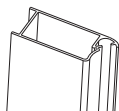



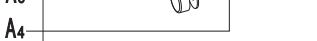



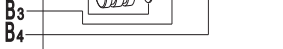

NO.	Designation	Pieces	NO.	Designation	Pieces
1		X1	11.1		X1
2		X1	11.2		X1
3		X2	12.1		X1
4	 $\phi 8$	X6+1	12.2		X1
5	 ST4X35	X6+1	13		X1
6	 ST4X10	X4+1	14		X1
7		X4+1	15		X1
8		X1	16	A ₁ 	X2
9.1		X1		A ₂ 	X4
9.2		X1		A ₃ 	X8
10.1		X1		A ₄ 	X4
10.2		X1		B ₁ 	X4
				B ₂ 	X4
			B ₃ 	X2	
			B ₄ 	X2	
			C ₁ 	X4	
			C ₂ 	X4	
			C ₃ 	X2	
			C ₄ 	X8	
			C ₅ 	X4	
			C ₆ 	X2	
			D	No handle	
			17		X1
				 $\phi 8$ $\phi 3.2$	

1.



2.

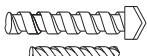
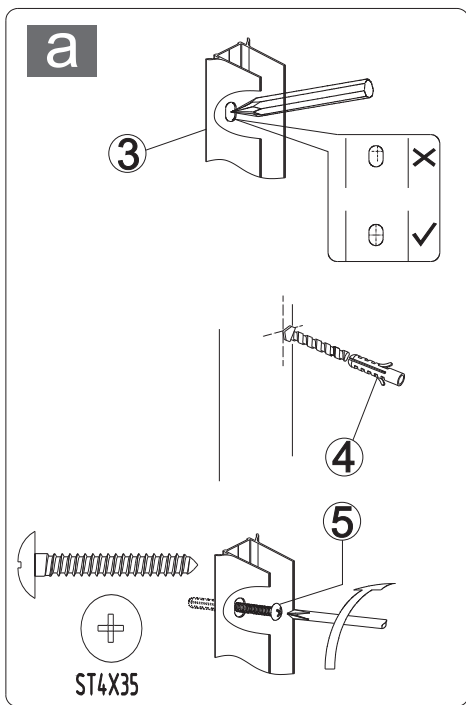
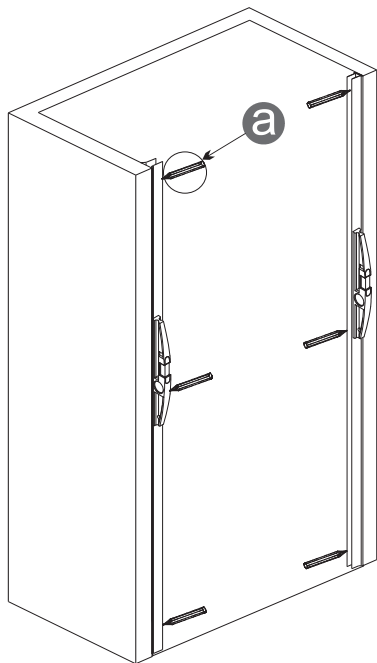
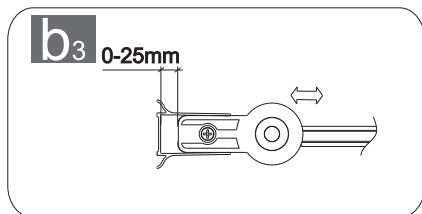
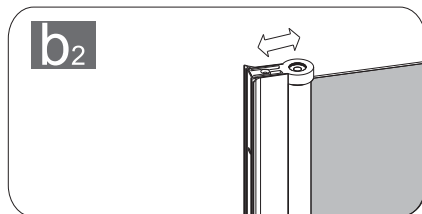
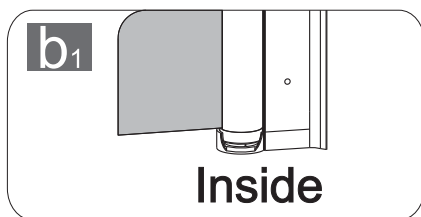
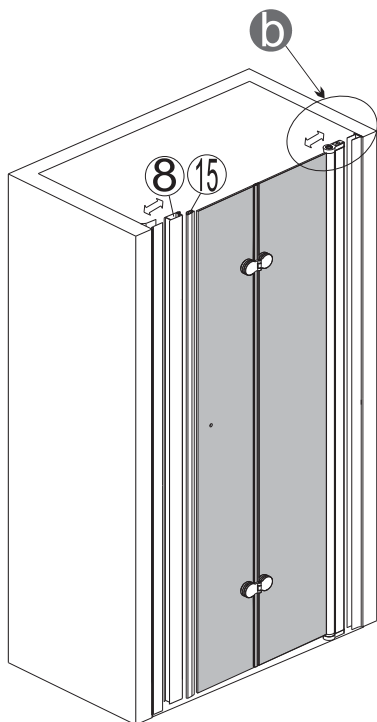

3.

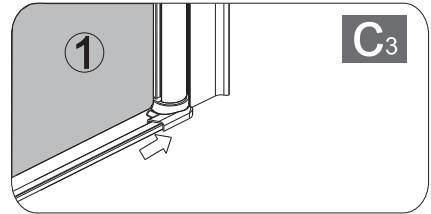
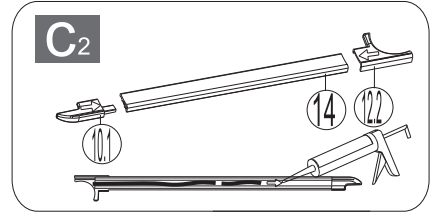
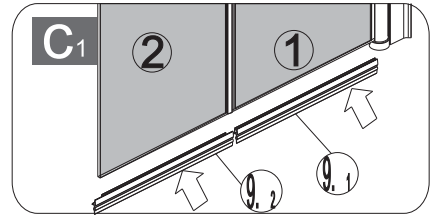
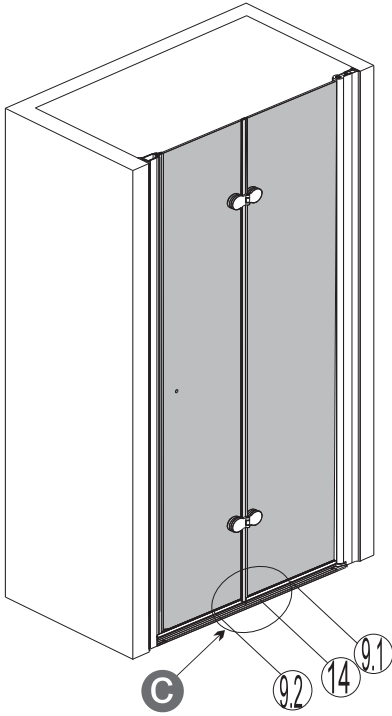

4.

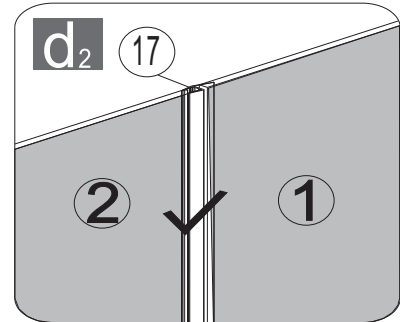
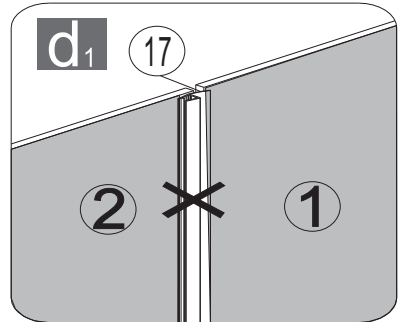
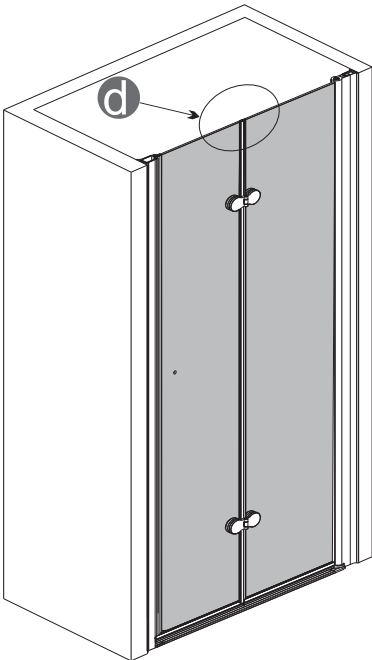

5.

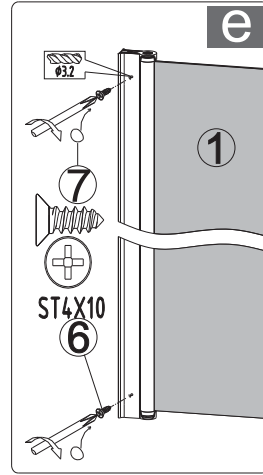
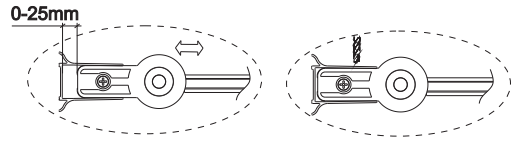
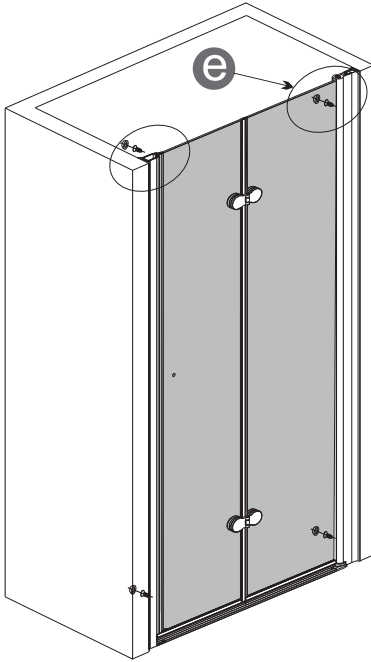

6.

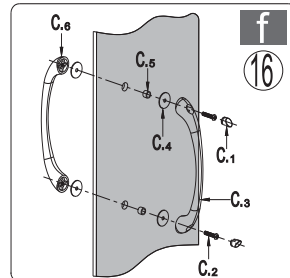
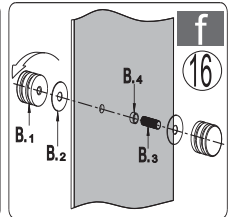
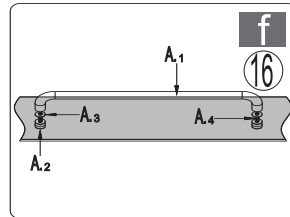
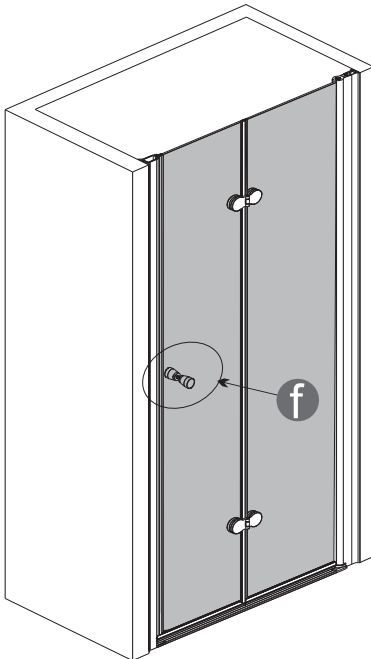

7.

