

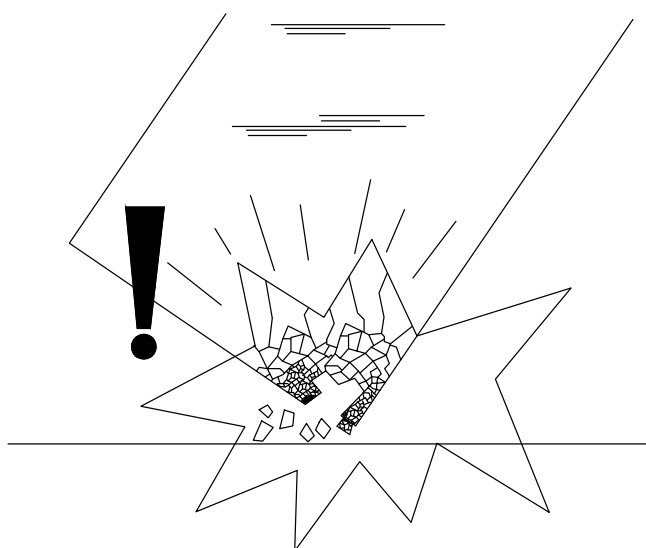

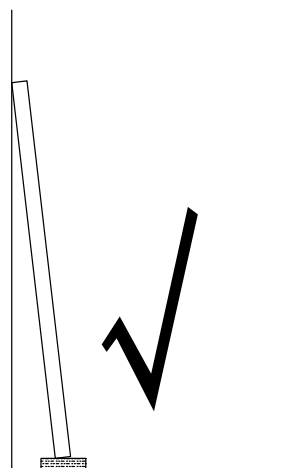

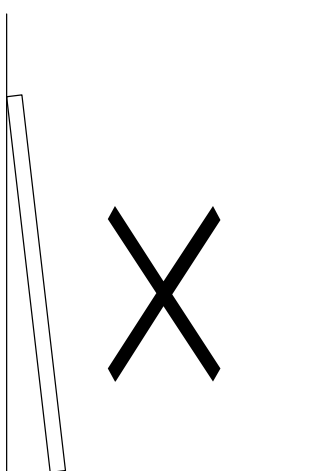

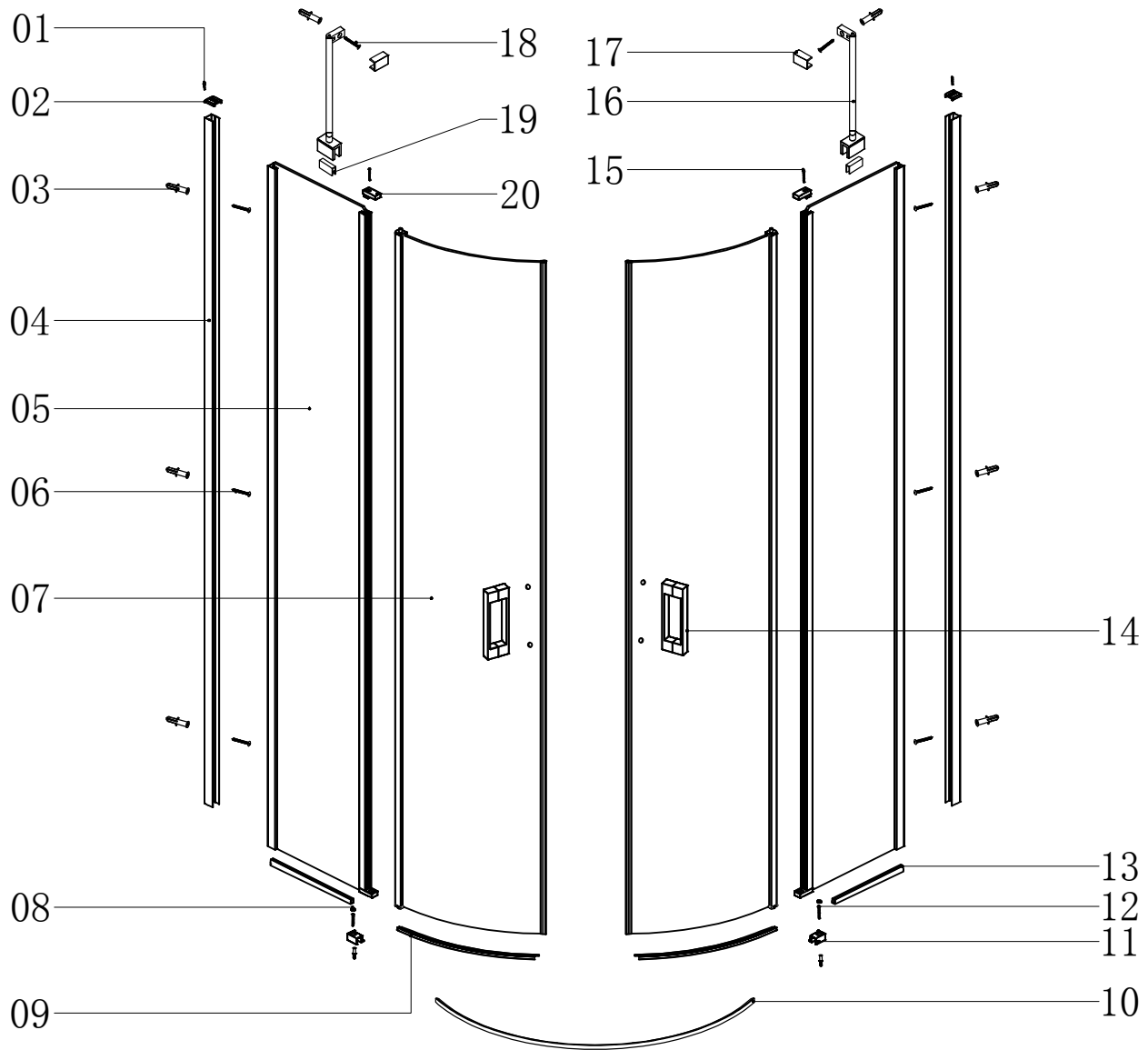





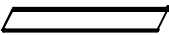







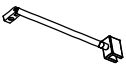

Ø6





Serial number	Graphical	Name	Quantity	Remarks
01		ST3. 5x38	2PCS	
02			2PCS	
03		∅6	10PCS	
04			2PCS	
05			2PCS	
06		ST3. 9X35	6PCS	
07			2PCS	
08			2PCS	
09			2PCS	
10			1PCS	
11		L/R	2PCS	
12		ST3. 9X35	2PCS	
13			2PCS	
14			2PCS	
15		ST3. 5X35	2PCS	
16			2PCS	
17			2PCS	
18		ST3. 9X35	2PCS	

serial number	graphical	Parameter	quantity	Remark
19			2 PCS	
20			2 PCS	
21		M2	1 PCS	
22		M3	1 PCS	
23			1 PCS	

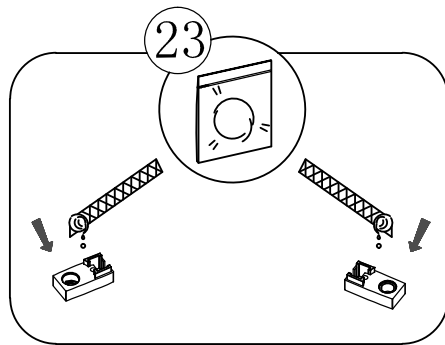

	A
800x800	785-800
900x900	885-900

